

ZEN 102

general tolerances where not expressly communicated $\pm 0.2\%$
 connection dimensions according to UNI EN 695

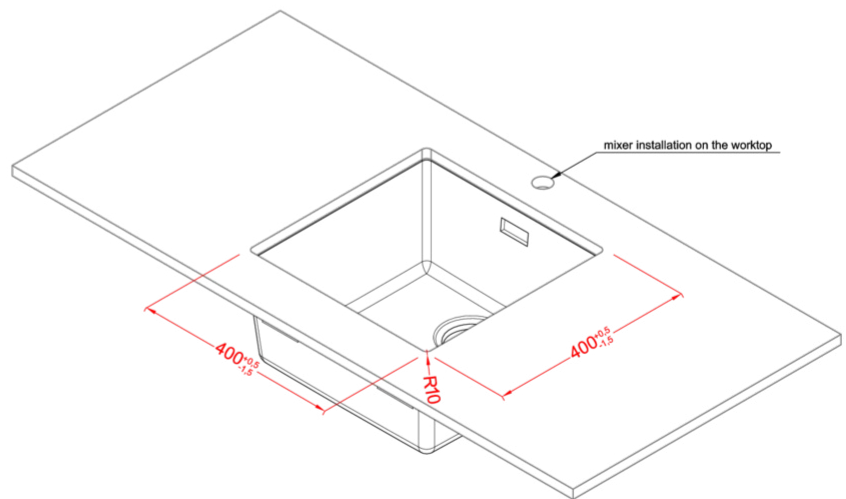

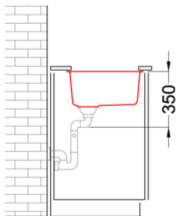
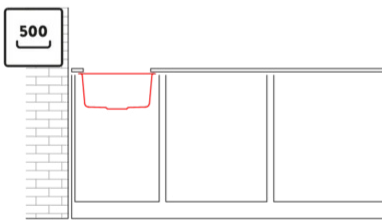
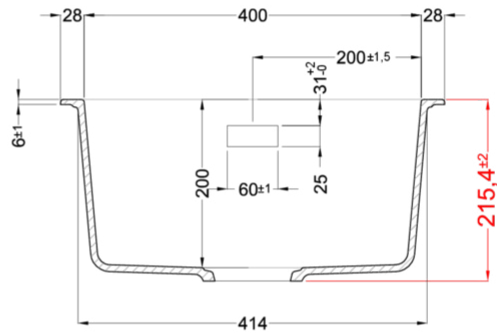
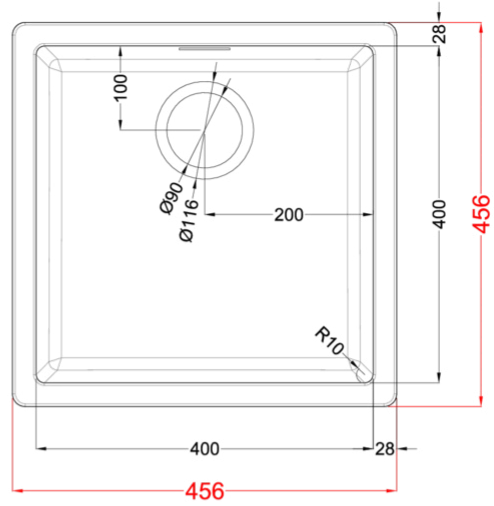
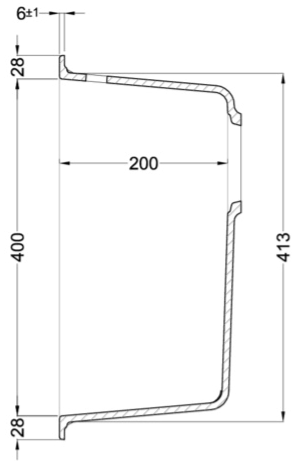

ZEN 102 UNDERMOUNT

general tolerances where not expressly communicated $\pm 0.2\%$
connection dimensions according to UNI EN 695

